

# 2014 RAM PROMASTER



**MASTER EVERY JOB.** INTRODUCING THE ALL-NEW 2014 RAM PROMASTER LINEUP. THE NEWEST MEMBERS OF THE RAM COMMERCIAL FAMILY DELIVER NEW BENCHMARKS WHERE THEY MATTER MOST, WITH AWESOME OPTIONS FOR POWER, VERSATILITY YOU CAN COUNT ON AND CONFIGURATIONS THAT ARE VIRTUALLY COUNTLESS. **PROMASTER MEASURES UP.** OFFERED IN THREE WEIGHT CLASSES, TWO ROOF HEIGHTS, FOUR DISTINCTIVE CARGO FLOOR LENGTHS AND THREE DIFFERENT WHEELBASES, RAM PROMASTER VAN WAS BORN WITH A WORLD OF WORK IN MIND. **EFFICIENT FROM THE GET-GO.** FROM THE PROVEN AND DURABLE 3.6-LITER PENTASTAR® V6 TO THE AVAILABLE 3.0-LITER ECODIESEL I4, PROMASTER WAS BUILT TO DELIVER. WHETHER A FACTORY CONFIGURATION OR AN UPFIT ON A CUTAWAY, CHASSIS CAB OR WINDOWED VAN, WHEN IT COMES TO WORKING LIKE A PRO, THERE'S NOTHING LIKE **THE ALL-NEW 2014 RAM PROMASTER.**

## ALL-NEW 2014 RAM PROMASTER

### CONTENTS:

2	<i>Introduction</i>	11	<i>Powertrains</i>	17	<i>Paint/Wheels/Fabrics</i>
5	<i>Capacity</i>	13	<i>Chassis/Suspension</i>	18	<i>Buyer's Guide</i>
6	<i>Payload</i>	14	<i>Interior</i>	19	<i>Technical Info</i>
10	<i>Upfit Solutions</i>	16	<i>ProMaster Family</i>	20	<i>Configurations</i>



**RAM**

**5 YEAR/100,000 MILE**  
POWERTRAIN LIMITED WARRANTY<sup>01</sup>

All Ram powertrains are covered by a fully transferable Powertrain Limited Warranty.<sup>01\*</sup>

# WORK WITH A

# REAL



# PRO

Properly secure all cargo.



Properly secure all cargo.

# THIS IS FULL CAPACITY AT YOUR SERVICE.

## NEW RAM PROMASTER VANS: A CAVERNOUS CARGO HOLD, BENCHMARK VERSATILITY, BACKED WITH SERIOUS BEST-IN-CLASS ADVANTAGES.

The challenge with all-new Ram ProMaster models isn't where to start the list of **class-exclusive features** and **best-in-class attributes**. It's where to finish that extensive list.

The new addition to the Ram Commercial family stands out in virtually every way, for Ram ProMaster is almost a completely different breed of vehicle. Instead of the typical rear-wheel-drive configuration, all models deliver front-wheel-drive engineering. Rather than one average engine and transmission, you have the choice of either gas or diesel power — with optimized transmissions helping to achieve enviable fuel efficiency. ProMaster Van models offer remarkable interior configurability, ultra-durable body/frame unibody construction (contributing to **best-in-class<sup>[2]</sup> cargo van payload\*** on select models), with **best-in-class<sup>[2]</sup> load height** ensuring total ease for entry/egress.

All-new for the Ram family, these commercial workhorses carry the prestige of more than 30 years of powertrain development and vehicle architecture. Proven engines, state-of-the-art transmissions, ongoing refinements in body design to help minimize downtime, and innovative front-wheel-drive models that include Cutaways, Chassis Cabs and Windowed Vans — all built on the same platform — put new Ram ProMaster in a league of its own.

**LEFT, TOP:** Ram ProMaster 3500, 159-inch wheelbase with High Roof, delivers the goods with **best-in-class<sup>[2]</sup> cargo width between the wheel wells** in the rear cargo area.

**LEFT, BOTTOM:** Ram ProMaster 3500, 159-inch wheelbase with the spacious High Roof. Nearly vertical side walls let you configure your ProMaster into the mobile workshop that's ideal for your business. Hauling or delivering? Expansive side and rear doors easily accommodate standard-size pallets.

### STANDARD ROOF

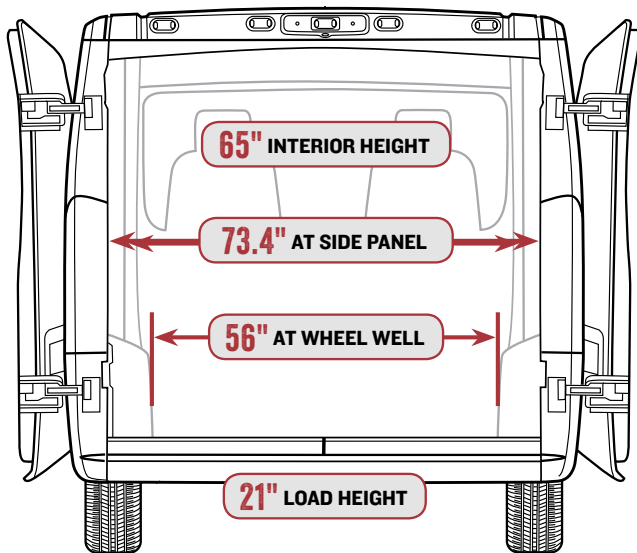

**353** CUBIC  
FEET\*

### HIGH ROOF

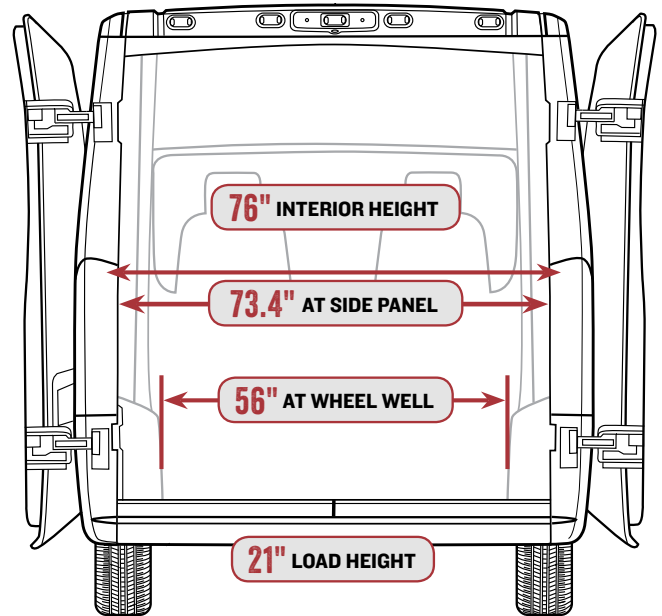

**530** CUBIC  
FEET\*

\*When properly equipped.

# BIG PAYLOAD, BIG PAYOFF.

## MEASURE CAPABILITY BY SUPERIORITY: CARGO VAN PAYLOAD IS BEST-IN-CLASS.<sup>[2]\*</sup>

**W**hen you set out to design a work vehicle that can make its mark on the working world, you think about the rear compartment right up front. In designing the new Ram ProMaster Van, engineers were open to keeping the cargo compartment as cavernous as possible. The end result: ProMaster has numbers that stand out.

The new 2014 Ram ProMaster Vans were engineered with short dash-to-front-axle measurements that let you put more in back. Its near-vertical side walls approach an ideal 90-degrees-from-the-floor convenience.

Versatility comes courtesy of three wheelbases, four lengths and two roof heights. The available High Roof option extends interior height to provide 76 inches of floor-to-ceiling clearance. The low load floor also delivers **best-in-class<sup>[2]</sup> load height** that measures in inches but is appreciated in ways that are immeasurable. The interior capacity also measures up: regardless of configuration, every Ram ProMaster provides **best-in-class<sup>[2]</sup> cargo width between the rear-wheel housings**. From accommodating one more pallet of product to allowing flat packing of an item that would be angled against the wheel well in any other van floor;

the fact that larger items can lay flat further helps this van stand out. Where other engineers might have settled for **best-in-class<sup>[2]</sup> cargo van payload,\*** for Ram ProMaster it was only the beginning.

The versatile design just starts the list of ProMaster assets. What counts big are the driving dynamics, road manners and braking capability while doing the job. Here, Ram ProMaster rules, with chassis that deliver professional-grade driveability and brakes that offer equal levels of performance and durability. The gas and diesel powertrains give you an ideal mix of horsepower and torque. Again, the Pentastar® V6 rules, with **best-in-class<sup>[2]</sup> standard V6 horsepower and torque**.

Put it all together, and it's obvious: this design is all about keeping costs at bare-bones minimums while delivering **best-in-class<sup>[2]</sup> cargo van payload capability.\*** No vehicle out there quite matches Ram ProMaster.

**RIGHT:** Ram ProMaster 3500 Chassis Cab and 3500 Van demonstrate complete adaptability for transporting cargo.

**BELOW:** Ram ProMaster 3500 with standard wheelbase and High Roof allows exceptional loads — and exceptional hauling. Space here maxes out at 459 cubic feet; side and rear doors easily accommodate standard pallets.



Properly secure all cargo.



### PAYLOAD

(Weights given in lb.)

	CARGO VAN						WINDOWED VAN	CHASSIS CAB			CUTAWAY			
	1500		2500		3500		2500	3500			3500			
	118" WB	136" WB		136" WB	159" WB	159" WB	159" WB, EXTENDED	159" WB	136" WB	159" WB	159" WB, EXTENDED	136" WB	159" WB	159" WB, EXTENDED
STANDARD ROOF	STANDARD ROOF	HIGH ROOF	HIGH ROOF		HIGH ROOF		HIGH ROOF	HIGH ROOF						
<b>MAX PAYLOAD* GAS ENGINE</b>	3,982 <sup>1</sup>	3,912	3,820	4,119 <sup>1</sup>	3,976	4,400 <sup>1</sup>	4,148	3,916	5,145 <sup>1</sup>	5,123	5,090	5,189 <sup>1</sup>	5,167	5,134
<b>MAX PAYLOAD* DIESEL ENGINE</b>	3,742 <sup>1</sup>	3,672	3,580	3,879 <sup>1</sup>	3,736 <sup>1</sup>	4,160 <sup>1</sup>	3,908 <sup>1</sup>	3,676	4,978 <sup>1</sup>	4,934	4,901	5,022 <sup>1</sup>	4,978	4,945

\*When properly equipped. <sup>1</sup>Max payload based on body model, GVWR class. Specifications subject to change. See dealer for most up-to-date information.



Properly secure all cargo.



# CARGO HOLD

Properly secure all cargo.





Properly secure all cargo.

# IDEAL FOR ONE UPFIT: YOURS.

WHEN YOU INVEST IN AN UPFIT, YOU NEED TO START WITH A FOUNDATION THIS SOLID.

The numbers are impressive from the get-go, and it's clear that the 2014 Ram ProMaster models are destined to figure large — especially when the figures serve to boost your bottom line. When it comes to upfits, these commercial vans — whether the 1500, 2500 or 3500 weight classes — were built to be blank canvases. Powered by two long-proven engines, each mated to the ideal transmission, these vehicles were designed to make life easy for those who make their living outfitting upfits — and those whose livelihood depends on using them.

This is where versatility, convenience and configurability meet virtually every business need. Choose from four floor lengths, three wheelbases, two roof heights (standard roof height includes **best-in-class**<sup>[2]</sup> **standard interior ceiling height** of 65 inches) and even a distinctive windowed version when a passenger van is the solution.

Cutaway/Chassis Cab models — 3500-class heavyweights that provide a solution when a back-wall partition is needed or not — come in two wheelbases with standard roof height only.

From an intelligently designed modular exterior to crafted interiors based on operator comfort and ease-of-upfit, this is the Ram you choose when outstanding interior room, best-in-class<sup>[2]</sup> cargo van payload,\* and impressive versatility serve to level the playing field for your business.

**LEFT:** *Ram ProMaster is one worker with a can-do attitude — and a do-it-all design. This upfit capitalizes on the nearly vertical side walls and High Roof option to provide ample room for work space, storage and shelving.*

**BELOW:** *Everything about new Ram ProMaster is about the upfit — even the smart and upfitter-friendly placement of the DEF port on EcoDiesel-powered models that minimizes upfit time and helps reduce costs. Below, left to right, a 159-inch WB ProMaster Chassis Cab has been transformed into a functional flat bed, a gigantic aftermarket cube body — ideal for deliveries — and a luxurious and spacious camper body.*

\*When properly equipped.



**DESIGNED FOR VERSATILITY AND LOW COST OF OWNERSHIP.** The look is distinctive — and totally practical. The exterior engineering of this cab is all about maximum use and minimal downtime. Look for a convenient frame height of only 25.5 inches; oversized, bright-finished, high-positioned headlamps out of the way of common collision zones, and in a downward-facing direction for the best possible down-the-road beam and peripheral illumination; a three-piece modular front fascia for simplified service, which helps to reduce replacement costs; and, in Cutaway models, easy walk-through access from cab to cargo area or upfit.

The windshield on all models is expansive. Tall and wide, it's one of the largest in the segment, and ensures exemplary outward view. Structureless wiper blades provide a premium appearance and reduced wind noise.

History proves the Ram ProMaster mettle. The root vehicle — the popular FIAT® Ducato — has proven itself one of the most versatile and upfit-friendly chassis cabs on the international market; the designed-in versatility of the vehicle has won accolades literally around the world — and it's frequently the go-to choice for upfits in Europe.



**PEOPLE MOVER: RAM PROMASTER WINDOWED VAN IS JUST THE TICKET.** Engineered only with a 159-inch wheelbase, and with an expansive floor and generous interior volume, the Ram ProMaster Windowed Van can be upfitted to move people, luggage and specialized equipment with ease.

Windowed Van versatility is all about adapting to multiple uses, ranging from shuttle applications (conventions, churches and airports are common) to specialized areas — in particular, the growing health care segment. This expansive and configurable interior makes applications for wheelchairs and special needs comfortable and simple.

# EFFICIENCY MEETS ECONOMY.

STRENGTH, EFFICIENCY AND DURABILITY: THESE TEAM PLAYERS WERE DESIGNED TO HIT THE GROUND RUNNING.

Reliability that exceeds the need, with stunning power and efficient performance: little wonder why the Pentastar® V6 has earned multiple awards.

The design saves space and contributes to outstanding fuel efficiency; this is one of the lightest and most impressive powerplants of its kind.

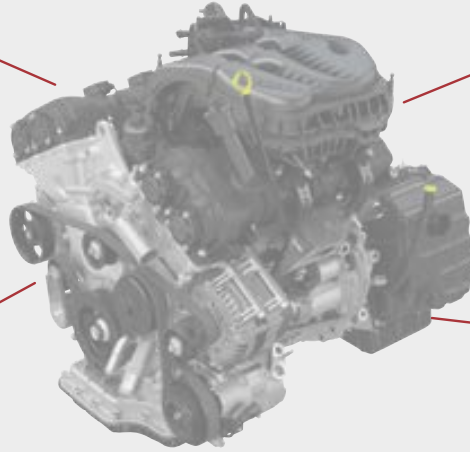

Torque is critical. The Pentastar V6 torque curve exceeds 90 percent of the peak value in the 1,600–6,400 rpm range — ideal calibration to provide power along with smooth and responsive driving.

Most competitive vehicles use a four-point mounting system for the engine. Modifications to the Pentastar V6 for Ram ProMaster create an innovative three-point system that helps mitigate noise, vibration and harshness (NVH). To that, add select-fit lightweight pistons and an inverted-tooth chain drive that greatly reduces sprocket contact.

## THE PROVEN 3.6L PENTASTAR V6

**280** HORSEPOWER **260** LB-FT OF TORQUE



Ram pickups broke all-new ground last year when the Brand incorporated the efficiency and capability of the 3.6-liter Pentastar V6 powerplant. When the designers of the Ram ProMaster models noted the acclaimed figures the Pentastar V6 delivered for towing and hauling, it was a natural match. New 2014 Ram ProMaster models mate the proven Pentastar V6 with the 6-speed automatic, a standard powertrain configuration that earns ProMaster top-tier consideration.

This award-winning engine has been optimized for the commercial market, with advanced sequential multiport fuel injection; electronic throttle control with available integrated cruise control; coil-on-plug ignition; dual overhead cams with four valves per cylinder and variable cam phasing. The upshot is superiority: the Pentastar V6 in a Ram ProMaster gives you **best-in-class<sup>[2]</sup> standard V6 horsepower and torque** while delivering competitive fuel efficiency.

**DURABILITY, DEFINED.** *Pentastar V6 factors for long-life performance and fuel efficiency are numerous; they include the “Silent Chain” timing drive, dual overhead cams, high-flow “tumble” intake ports and a seriously authoritative 10.2:1 compression ratio.*

**COST OF OWNERSHIP, MINIMIZED.** *In the latest iteration of the 3.6L Pentastar V6, we’ve introduced a no-maintenance camshaft drive and valvetrain; with spark plugs designed to operate for 100,000 miles before replacement, downtimes are kept to a bare minimum.*

**INTELLIGENT USE — AND DISPOSAL — OF OIL.** *A major mandate: reduce vehicle operating costs. These recommended oil change intervals approach a new best-in-class<sup>[2]</sup> benchmark: 10,000 miles, and are based on software recommendations — not a presumed time frame. Distinctively “green” in nature, we also utilize an environmentally friendly paper oil filter. Oil is extracted, recycled...and the cartridge is then incinerated.*

**PROVEN BY PUNISHMENT.** *This engine is robust from the get-go: our engineers subjected it to more than 3.8 million miles of customer-equivalent testing and 57,000 hours of dynamometer testing.*

## RYING FOR LEADERSHIP IN FUEL EFFICIENCY. ENSURING EFFICIENT LOW COST OF OWNERSHIP.

**FUEL EFFICIENCY THAT AIMS FOR THE TOP:** *New Ram ProMaster models with the 3.0-liter EcoDiesel I4 are anticipated to deliver phenomenal fuel efficiency, thanks to the advanced electronically controlled high-pressure Common Rail Fuel Injection System and a new variable geometry turbocharger with intercooler.*

**ENHANCED FOR HIGH VEHICLE UP-TIME:** *This in-line four-cylinder features an oil life sensor, an Oil Coalescent Filter System with high-efficiency filtration, hydraulic valve lash adjusters, cylinder liners with high-wear characteristics, oil-jet cooled pistons and a maintenance-free chain-timed camshaft.*



The mix of technologies is by design. The common-rail, high-pressure (2000 bar), electronically controlled Fuel Injection System helps maximize performance.

The oil pan is suspended, reducing resonance and lowering ambient engine noise; the engine block is one of the stiffest; and a dual-mass flywheel eliminates gear box rattle. In short: this is one of the quietest and best-performing turbo diesels on the market.

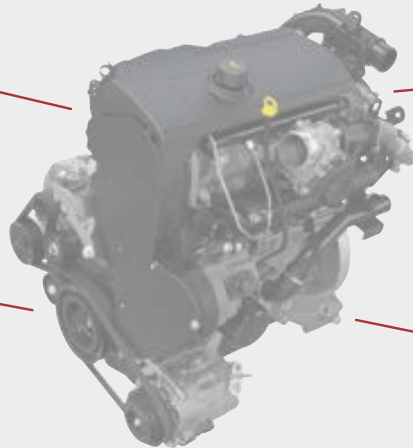

This easy-to-maintain and environmentally friendly engine utilizes a sophisticated Diesel Exhaust Fluid (DEF) System; unlike many competitors, our DEF port is next to the fuel filler port. The EcoDiesel I4 also offers exceptional fuel flexibility; it's calibrated to run on low-sulfur diesel or reduced-emissions — and biodegradable — B7 biodiesel.

Outstanding engineering translates into time- and money-saving advantages. Oil changes are based on use, not an arbitrary time frame; the best-in-class<sup>[2]</sup> 18,500 miles between system-recommended oil changes is one of ProMaster's greatest assets.

## THE REMARKABLE 3.0L ECODIESEL I4

**174 HORSEPOWER** **295 LB-FT OF TORQUE**



Available for all models, the turbocharged 3.0L EcoDiesel I4 is the only in-line four-cylinder turbocharged diesel engine in the competitive set. As part of an engine family that's often applied to higher weight classes using rear-wheel-drive technology — Class 4 applications are commonplace — this engine in the front-wheel-drive, lesser-weight Ram ProMaster models delivers ultra-capable horsepower and torque.

Hardly a newcomer to the business world, the turbocharged 3.0-liter EcoDiesel I4 is currently in its sixth generation. Clean-burning and lightweight, it is mated to the exceptional and **class-exclusive<sup>[2]</sup> automated clutchless manual transmission**. Oil change intervals with the EcoDiesel I4 are so infrequent, you can travel up to a **best-in-class<sup>[2]</sup> 18,500 miles** between recommended changes.

**CLEAN BY DESIGN.** *Fuel sources vary in quality; climates across the continent are like night and day. The turbocharged 3.0L EcoDiesel I4 utilizes dual-filtration technology for greater protection against contamination, reducing injector corrosion and enhancing durability.*

**CLEAN BY NATURE.** *Count on minimal CO<sub>2</sub> levels and biodiesel (B7)-approved calibration, with outstanding fuel efficiency.*

**CLASS-EXCLUSIVE<sup>[2]</sup> TRANSMISSION.** *The 3.0L EcoDiesel I4 is mated to the distinctive automated clutchless manual transmission — a component engineered to meet the specialized commercial needs of this new Ram. The 6-speed automated clutchless manual is an exclusive offering in the Ram ProMaster competitive set, enabling the driver to shift gears with no use (or presence) of a typical clutch. The transmission offers performance that combines fuel efficiency with capability; the driver-selectable Tow/Haul Mode is standard, and long-life transmission fluid — with a 60,000-mile recommended fluid check/change interval — also contributes to low costs of ownership.*

# CLEARLY, A SMARTLY DESIGNED BUSINESS PLAN.

Outfit your Ram ProMaster with two available assets that can be indispensable when parking and maneuvering: ParkView® Rear Back-Up Camera<sup>[3]</sup> (with grid lines displayed on the screen) and ParkSense® Rear Park Assist,<sup>[3]</sup> with ultrasonic sensors discreetly integrated into the rear bumper.

Critical to ProMaster road manners, handling and overall performance is the comprehensive Electronic Stability Control (ESC)<sup>[4]</sup> System, which includes ABS, a Brake/Lock Differential, Traction Control, Brake Assist, Engine Drag Control, Trailer Sway Control,<sup>[4]</sup> Hill Start Assist, Drift Compensation, Rollover Mitigation and Automatic Brake Lamp Actuation.

On ProMaster Van models, roof strength measures up, with a 330-lb weight rating and six roof rail mounts — three on each side. All exposed body panels on every model are galvanized for long-term corrosion protection.

A unique and premium steering gear enhances drive quality and reliability, and it contributes to the incredibly tight turning circle; it's a mere 36 feet on ProMaster short wheelbase models — and it's best-in-class.<sup>[2]</sup>

The front-wheel-drive configuration utilizes a telescoping steering column that controls crisp rack-and-pinion hydraulic steering. Steering control is firm, responsive and confident.

Thanks to the front-wheel-drive engineering, the rear suspension is a category-unique beam axle/leaf spring configuration that's lighter, simpler, and just as robust as rear-wheel-drive vehicles. Eliminating the need to design around the typical "hump" of rear-wheel-drive vehicles gives you a super-low load floor — and that best-in-class<sup>[2]</sup> load height of only 21 inches.



It's designed for convenience — and to help protect cargo. The standard load floor offers up to ten steel tie-down rings, each rated at 1,000 lb, to secure cargo; additional rings (in the walls and partitions) can total up to 17. Pre-cut holes in the available resin-finished wood load floor guarantee easy access to every ring.

The body-frame integral design meets the need for unyielding strength for the job: this is a high-strength steel framework with all crossmembers, floor pan, longitudinal rails and side panels (on ProMaster Van models) integrally welded together.

The proven MacPherson strut front suspension features large (62 mm) twin-tube shocks for outstanding support of cargo; GVW-tuned cast iron control arms offer outstanding durability. Brakes are Brembo® four-wheel disc and measure an impressive 11.8 inches in diameter.

**THREE-PIECE MODULAR FRONT END.** Every model in the ProMaster portfolio features a three-piece modular front end to help mitigate costly repairs and enhance uptime. The unique oversized headlamps and taillamps are all high-mounted out of the crash zone; headlamps are positioned for outstanding down-the-road and peripheral illumination. Five standard roof-mounted front clearance lamps convey the expansive width of this breakthrough commercial vehicle.



## WE TESTED IT TO THE EXTREME — SO YOU CAN TAKE IT TO EXTREMES.

These commercial-grade workhorses have been tested in work situations, climates, temperatures and terrains that can only be described as brutal. Testing conditions vary from icy/snowy roads in Sweden to the deserts of Nevada, where temperatures range from an arctic-like -40°F to sweltering 125°F heat waves. From the standpoints of reliability and durability, Ram ProMaster performs with exceptional quality.

- A** All components of the chassis are joined via advanced welding techniques at all interfaces; as many as 5,000 spot welds are used to ensure structural integrity. Strategic locations are further strengthened with structural adhesives.
- B** Front crash zones are engineered to absorb energy — and they do it with complete proficiency. The fact that this is a ready-to-work commercial vehicle in no way compromised our efforts to create a vehicle known for its safety and security features. In fact, quite the contrary: the newest additions to the Ram Commercial family have arguably undergone the most extensive crash and safety testing in the history of the company.
- C** Construction here is body-frame integral — BFI, or unibody; most competitive models employ the more common body-on-frame design. The Ram ProMaster system, with its upper and lower front crossmembers, provides stability and finer tuning of chassis systems and related hardware.
- D** Ram ProMaster Chassis Cab models were designed with the anticipation of formidable upfits and consequently higher weights; to meet that end, we added an upper underbody structure consisting of a steel I-beam overlay.

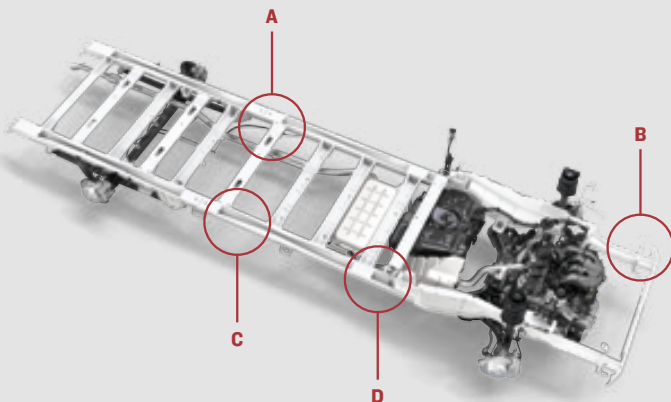



# THE IDEAL OFFICE ON THE GO

*doesn't require any work at all.*

**W**ithout doubt, the power, capability and character of the 2014 Ram ProMaster Vans and Cutaway/Chassis Cabs create an ideal work vehicle for the job.

Little surprise to discover that the operations center used for day-to-day tasks and year-to-year assignments is handsomely appointed, with generous driver and passenger room, available front seating to accommodate three adults, the latest communications technologies and ample storage with flat-floor convenience. It's all backed with optimal ergonomic design for complete operator comfort.

This cab-forward interior offers big-rig practicality with sedan-like amenities. The expansive windshield — with standard solar-filter glass — works with high-positioned driver/occupant seating for **best-in-class<sup>[2]</sup> driver visibility and ergonomic driving position**. Controls and knobs are large-sized with rubberized surrounds — perfect for gloved hands. Access to the rear is unhindered and convenient.

The instrument panel is low-gloss with a grained upper panel that greatly reduces glare and “hot spots”. Readability is key: bright-finished appointments for the HVAC, radio and other controls join a crisp

LED-illuminated cluster along with an intuitive center-positioned vehicle information center. Even the parking brake is ideally positioned to the driver's left, allowing instant visual recognition that it's engaged when entering the vehicle.

Storage is abundant: three separate compartments in each door, including oversized door pockets; triple center-stack cup holders; upper instrument panel storage (holding some three liters of space); oversized and available lockable glove compartments; an interior storage bin on the passenger side; there's even an available overhead shelf system. You need your space. Ram ProMaster provides it.

The finishing touches are found in the electronics, with a 12-volt power outlet, 2.5-amp fast-charging instrument panel-mounted USB port, and available Uconnect® radio.

Compare it all, and the advantages are obvious. From the exceptional seat selection, interior configurability and sheer comfort, few vehicles match Ram ProMaster.





Properly secure all cargo.



## OPEN FOR BUSINESS: EASY REAR ACCESS IN PROMASTER VAN AND CUTAWAY MODELS.

The standard configuration for Ram ProMaster Van offers premium convenience: instant access to the spacious rear. With no partition, you've got a huge opening between the standard seats; opt for the swivel bucket seats\* and you can take advantage of a very convenient 180-degree rotation.

The absence of the rear wall in the Cutaway models offers the same easy accessibility to the upfit area. It's an ideal flat-floor design for intensive-use applications like ambulances, food service vehicles or mobile work stations.

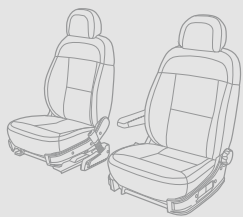

### Seating Options

#### BUCKET SEATS

Standard are tubular-structured bucket seats with spring suspension. Woven cloth is standard; available vinyl, manual lumbar support, heated seat surfaces.

#### DRIVER'S SUSPENSION BUCKET SEAT

The available premium driver's Suspension Seat adds a pneumatic suspension and a weight/size conformity adjustment knob.

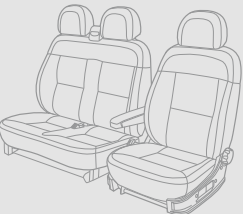

#### THREE-OCCUPANT SEATING

Here, the single driver's bucket seat is joined by an integrated two-seat bench seat; in-cab capability is also enhanced: the middle seat-back insert folds down, offering an instant and convenient writing surface.

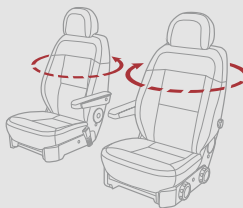

#### SWIVEL SEATING\*

Need to access the rear compartment with ease? Available swivel bucket seats in long-wearing cloth are the answer, with 180° inboard swivel range, 35° outboard swivel, 58° recliner and a continuous height adjuster.

\*Late availability.

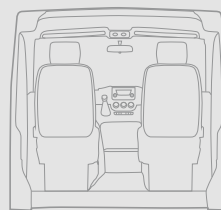

### Partition Options

#### NO PARTITION

Standard for ProMaster Van models, and providing instant and easy access to the rear cargo compartment.

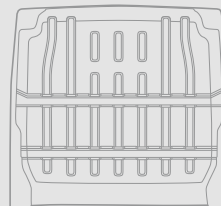

#### FULL PARTITION

This optional amenity lets you add security and control by separating the forward cabin from the rear cargo compartment. Available partition covers and panels keep things quiet.

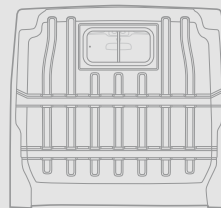

#### FULL PARTITION WITH WINDOW

Another available amenity that focuses on security, while allowing the operator and/or passenger the ability to monitor the cargo area when safe. The sliding window also permits natural air flow.

THE RIGHT TOOLS



FOR THE JOB



« EXTERIOR COLORS »



« WHEELS »



16-inch Steel Wheel with Center Cap  
(Standard)



16-inch Wheel Cover  
(Available)



16-inch Aluminum Wheel  
(Available)

« INTERIOR FABRICS »



Black Cloth  
(Standard)

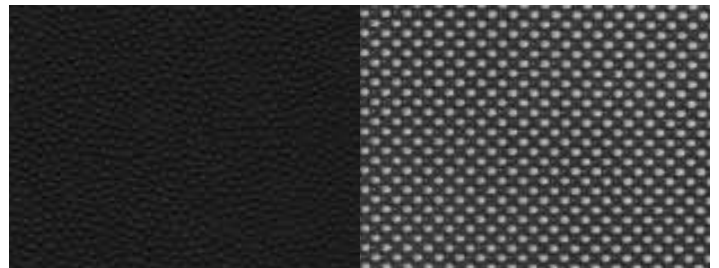

Black Vinyl  
(Available)

# 2014 RAM PROMASTER BUYER'S GUIDE

	Van	Windowed	Chassis Cab	Cutaway
<b>ENGINES AND TRANSMISSIONS</b>				
3.6L PENTASTAR® V6 WITH 6-SPEED AUTOMATIC TRANSMISSION	•	•	•	•
3.0L ECODIESEL I4 WITH 6-SPEED MANUAL/AUTOMATED TRANSMISSION	0	0	0	0
<b>SUSPENSIONS</b>				
LIGHT DUTY	• (1500 SWB)			
MEDIUM DUTY	• (1500 LWB)			
HEAVY DUTY	• (2500/3500)	•	•	•
<b>MECHANICAL FEATURES</b>				
ALTERNATOR — 180-amp	•	•		
— 220-amp	0	0	•	•
BATTERY — 95-amp	•	•	•	•
— 100-amp	0	0	0	0
CRUISE CONTROL	0	0	0	0
ELECTRONIC STABILITY CONTROL <sup>(4)</sup>	•	•	•	•
ENGINE BLOCK HEATER (ECODIESEL I4 ONLY)	0	0	0	0
FUEL TANK — 24-gallon	•	•	•	•
POWER STEERING	•	•	•	•
<b>EXTERIOR FEATURES</b>				
DAYTIME RUNNING LIGHTS	0	0	0	0
DOORS, REAR — 260-degree-opening	•	•		
ENGINE SKID PLATE			0	0
EXTENDED WIRING — Taillamps			•	•
FRONT FOG LAMPS WITH BRIGHT GRILLE	0	0	0	0
HALOGEN HEADLAMPS	•	•	•	•
MIRRORS — Manual	•	•	•	•
— Power, heated	0	0	0	0
ROOF CLEARANCE LAMPS — Rear	•	•		
— Front	•	•	•	•
<b>INTERIOR FEATURES</b>				
12-VOLT AUXILIARY POWER — Front	•	•	•	•
— Rear	0	0		
AIR CONDITIONING — Manually controlled, with heat	•	•	•	•
— Delete Air Conditioning; heater only	0	0	0	0

	Van	Windowed	Chassis Cab	Cutaway
<b>INTERIOR FEATURES (continued)</b>				
CARGO LAMPS — Rear	•	•		
CARGO PARTITION — None	•	•		
— With window	0			
— Without window	0			
CARGO TIE-DOWN RINGS — Floor	•	•		
— Side-wall	0	0		
HEADLINER		0		
LOCKING GLOVE BOX — Cargo area	0	0	0	0
LUMBAR ADJUSTER — Manual	0	0	0	0
OVERHEAD STORAGE	0	0	0	0
POWER DOOR LOCKS	•	•	•	•
REAR DOOR STORAGE NET	0	0		
REAR HEATER AND AIR CONDITIONING PREP	0	0	0	0
SEATS — Cloth	•	•	•	•
— Cloth/vinyl	0	0	0	0
— Heated	0	0	0	0
STEERING COLUMN — Telescoping	•	•	•	•
STEERING WHEEL — Leather-wrapped	0	0	0	0
TIRE PRESSURE MONITORING LIGHT	•	•	•	•
UPFITTER'S ELECTRICAL MODULE	0	0	0	0
WALL PANELS — Full-side	0			
— Lower-side	0	0		
WINDOWS — Power	•	•	•	•
WOOD FLOOR — Rear	0	0		
<b>MULTIMEDIA</b>				
AM/FM/MP3	•	•	•	•
UCONNECT® 5.0	0	0	0	0
<b>SAFETY AND SECURITY</b>				
AIR BAGS <sup>(3)</sup> — Six	•	•	•	•
PARKSENSE® REAR PARK ASSIST <sup>(3)</sup>	0	0		
PARKVIEW® REAR BACK-UP CAMERA <sup>(3)</sup>	0	0		
REAR CAMERA WIRING PREP	•	•		
• = Standard 0 = Optional				
NOTE: Some features and/or applications may be late availability.				

## INCENTIVES AND SUPPORT FOR YOUR SMALL BUSINESS.

**ON THE  
JOB**

### INCENTIVES FOR SMALL BUSINESSES.

Running a business presents plenty of challenges. Like cutting costs, not corners. Like saving time, money and eliminating hassles. The **ON THE JOB**<sup>(6)</sup> commercial incentive program provides assistance in customizing and servicing your business vehicles.

Our most popular ON THE JOB incentives are:

- **COMMERCIAL EQUIPMENT/UPGRADES**  
» \$1,000/\$500 Allowances for Upfits.
- **COMMERCIAL GRAPHICS ALLOWANCES**  
» \$250/\$500/\$1,000 Commercial Graphics Allowances.
- **BOSCH® TOOL OFFER**  
» Select 1 of 4 All-New Bosch Power Tool Packages.
- **2-YEAR/30,000-MILE LUBE/OIL/FILTER**  
» For all Ram, Chrysler, Jeep, and Dodge vehicles.  
Includes gas and diesel engines.

See your dealer for specific program rules and details, or call us toll-free at **877-ONTHEJOB (877-668-4356)**.



### THE DEALER NETWORK FOR YOUR BUSINESS.

BusinessLink has you covered.

- Next-Bay Service (All Makes and Models)
- Extended Service Hours
- A Dedicated BusinessLink Staff
- Commercial Vehicles in Stock
- Free Loaners\* for Selected Vehicles
- Convenient Shuttle Services

For more information, log on to [chryslerbusinesslink.com](http://chryslerbusinesslink.com) or call us toll-free at **877-THELINK (877-284-3546)**.

\*Some restrictions apply. See dealer for details.

**CHRYSLER**  
CAPITAL

A commercial line of credit from Chrysler Capital is ideal for qualified business customers looking for a flexible, easy way to manage growing vehicle needs. Chrysler Capital streamlines the process — and with prequalification, you're ready to buy a vehicle when you need it. Ask your **BusinessLink** dealer for details.

## SPECIFICATIONS

	CARGO VAN							WINDOWED VAN
	1500			2500		3500		2500
	118" WB	136" WB		136" WB	159" WB	159" WB	159" WB, EXTENDED	159" WB
	STANDARD ROOF	STANDARD ROOF	HIGH ROOF	HIGH ROOF		HIGH ROOF		HIGH ROOF
<b>GVWR (LB)</b>	8,550	8,550	8,550	8,900	8,900	9,350	9,350	8,900
<b>GCWR (LB) GAS/DIESEL</b>	11,500 / 12,500	11,500 / 12,500	11,500 / 12,500	11,500 / 12,500	11,500 / 12,500	11,500 / 12,500	11,500 / 12,500	11,500 / 12,500
<b>CURB WEIGHT (LB) GAS ENGINE (WITHOUT OPTS)</b>	4,568	4,638	4,730	4,781	4,924	4,962	5,202	4,984
<b>CURB WEIGHT (LB) DIESEL ENGINE</b>	4,808	4,878	4,970	5,021	5,164	5,202	5,442	5,224
<b>MAX PAYLOAD (LB) GAS ENGINE*</b>	3,982	3,912	3,820	4,119	3,976	4,400	4,148	3,916
<b>MAX PAYLOAD (LB) DIESEL ENGINE*</b>	3,742	3,672	3,580	3,879	3,736	4,160	3,908	3,676
<b>FRONT GAWR (LB)</b>	3,883	4,630	4,630	4,630	4,630	4,630	4,630	4,630
<b>REAR GAWR (LB)</b>	4,667	5,291	5,291	5,291	5,291	5,291	5,291	5,291
<b>TURNING CIRCLE (FT)</b>	36.3	40.7	40.7	40.7	46.8	46.8	46.8	46.8

## DIMENSIONS

<b>BODY HEIGHT (IN)</b>	90	90	101	101	101	101	101	101
<b>OVERALL BODY LENGTH (IN)</b>	195	213.1	213.1	213.1	236	236	250	236
<b>VEHICLE WIDTH WITHOUT MIRRORS (IN)</b>	82.7	82.7	82.7	82.7	82.7	82.7	82.7	82.7
<b>VEHICLE WIDTH WITH MIRRORS FOLDED (IN)</b>	90.5	90.5	90.5	90.5	90.5	90.5	90.5	90.5
<b>VEHICLE WIDTH WITH MIRRORS EXTENDED (IN)</b>	98	98	98	98	98	98	98	98

## SPECIFICATIONS

	CHASSIS CAB			CUTAWAY		
	3500			3500		
	136" WB	159" WB	159" WB, EXTENDED	136" WB	159" WB	159" WB, EXTENDED
<b>GVWR (LB)</b>	9,350	9,350	9,350	9,350	9,350	9,350
<b>GCWR (LB) GAS/DIESEL</b>	11,500 / 12,500	11,500 / 12,500	11,500 / 12,500	11,500 / 12,500	11,500 / 12,500	11,500 / 12,500
<b>CURB WEIGHT (LB) GAS ENGINE</b>	4,205	4,227	4,260	4,161	4,183	4,216
<b>CURB WEIGHT (LB) DIESEL ENGINE</b>	4,445	4,477	4,500	4,411	4,423	4,456
<b>MAX PAYLOAD (LB) GAS ENGINE*</b>	5,145 <sup>†</sup>	5,123	5,090	5,189 <sup>†</sup>	5,167	5,134
<b>MAX PAYLOAD (LB) DIESEL ENGINE*</b>	4,978 <sup>†</sup>	4,934	4,901	5,022 <sup>†</sup>	4,978	4,945
<b>FRONT GAWR (LB)</b>	4,630	4,630	4,630	4,630	4,630	4,630
<b>REAR GAWR (LB)</b>	5,291	5,291	5,291	5,291	5,291	5,291
<b>TURNING CIRCLE (FT)</b>	40.7	46.8	46.8	40.7	46.8	46.8

## DIMENSIONS

<b>BODY HEIGHT (IN)</b>	90	90	90	90	90	90
<b>OVERALL BODY LENGTH (IN)</b>	211	234	248	211	234	248
<b>VEHICLE WIDTH WITHOUT MIRRORS (IN)</b>	82.7	82.7	82.7	82.7	82.7	82.7
<b>VEHICLE WIDTH WITH MIRRORS FOLDED (IN)</b>	92	92	92	92	92	92
<b>VEHICLE WIDTH WITH MIRRORS EXTENDED (IN)</b>	109	109	109	109	109	109
<b>CAB TO REAR AXLE<sup>‡</sup> (IN)</b>	81	104	104	81	104	104
<b>OVERHANG REAR AXLE TO END OF FRAME<sup>‡</sup> (IN)</b>	34	34	48	34	34	48

\*Max payload based on body model, GVWR class. When properly equipped. †Measured from center cab back to center of rear axle. ‡Measured from center of axle to rear frame. Specifications subject to change. See dealer for most up-to-date information.

RAM PROMASTER 1500

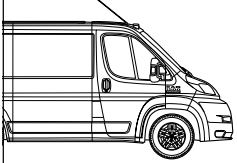

RAM PROMASTER 2500

RAM PROMASTER 3500

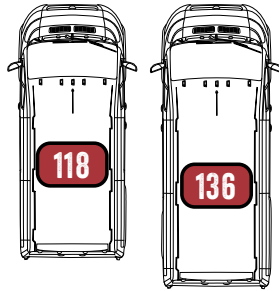

**CARGO VAN**  
STANDARD ROOF



 WHEELBASE LENGTH IN INCHES  
 BODY/CHASSIS EXTENDED 14 INCHES

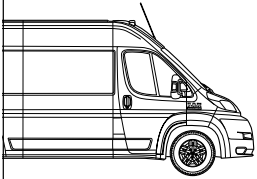

**CARGO VAN**  
HIGH ROOF

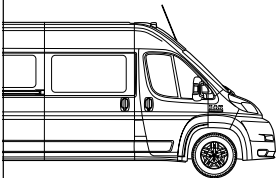
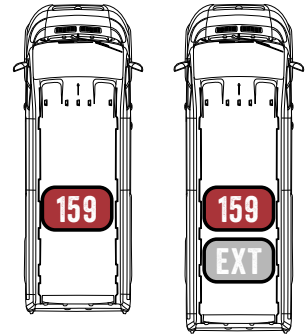
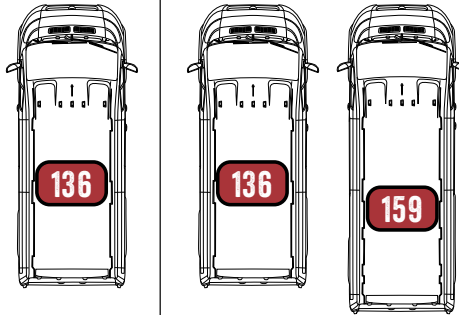

**WINDOWED VAN**  
(HIGH ROOF ONLY)

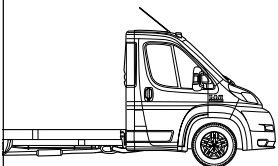
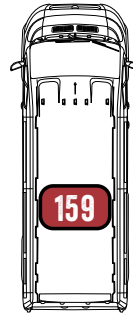

**CHASSIS CAB/  
CUTAWAY**  
(STANDARD ROOF ONLY)

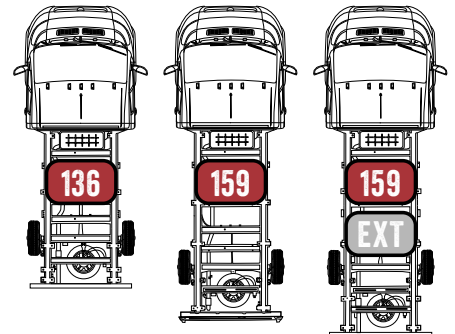



[RAMTUCKS.COM/COMERCIAL](http://RAMTUCKS.COM/COMERCIAL)

[1] Transferable. See your dealer for complete details and a copy of the 5-Year/100,000-Mile Powertrain Limited Warranty. [2] Based on Class 2 Large Commercial Van segment. [3] Always look before proceeding, electronic drive aid is not a substitute for conscientious driving, always be aware of your surroundings. [4] No system, no matter how sophisticated, can repeal the laws of physics or overcome careless driving actions. Performance is limited by available traction, which snow, ice and other conditions can affect. When the ESC warning lamp flashes, the driver needs to use less throttle and adapt speed and driving behavior to prevailing road conditions. Always drive carefully, consistent with conditions. Always wear your seat belt. [5] The Advanced Front Air Bags in this vehicle are certified to the new U.S. federal regulations for advanced air bags. Children 12 years old and younger should always ride buckled up in a rear seat. Infants in rear-facing child restraints should never ride in the front seat of a vehicle with a passenger front air bag. All occupants should always wear their lap and shoulder belts properly. [6] ON THE JOB is a retail incentive program; see your dealer for official rules. Inquire about eligibility by calling 877-ONTHEJOB or by logging on to [chryslercommercialvehicles.com](http://chryslercommercialvehicles.com). The purchaser or lessee must be a qualified commercial customer for more than 30 days prior to the date of the vehicle purchase. An official ON THE JOB Customer Acknowledgement Form must be signed by the customer (provided by the dealer).

About this catalog: Since the time of printing, some of the information you'll find in this catalog may have been updated. Ask your dealer for details. Some of the equipment shown or described throughout this catalog may be available at extra cost. Specifications, descriptions, illustrative materials and all competitive comparisons contained herein are as accurate as known at the time this publication was approved for printing. Chrysler Group LLC reserves the right to discontinue models at any time or change specifications without notice or without incurring obligation. Options may be required in combination with other options. For the price of the model with the equipment you desire, or verification of specifications contained here, see your Ram dealer. Brembo is a registered trademark of Brembo SpA. Sortimo is a registered trademark of Sortimo International GmbH. Knapheide is a registered trademark of Knapheide Manufacturing Company. Bosch is a registered trademark of Robert Bosch GmbH. Facebook and logo are registered trademarks of Facebook, Inc. The Twitter logo is a service mark of Twitter, Inc. The YouTube logo is a trademark of Google Inc. Instagram and logo are registered trademarks of Instagram, Inc. FIAT is a registered trademark of FIAT Group Marketing & Corporate Communications S. p. A., used under license by Chrysler Group LLC. iPad and iTunes are registered trademarks of Apple Inc. DensGlass® the color GOLD and the Georgia-Pacific logo are trademarks owned by or licensed to Georgia-Pacific Gypsum LLC. Chrysler, Dodge, Jeep, Ram, the Ram's Head logo, ParkSense, ParkView, Pentastar and Uconnect are registered trademarks and Ram ProMaster is a trademark of Chrysler Group LLC. © 2013 Chrysler Group LLC. All rights reserved.



Join fellow Ram enthusiasts and tell your story by posting comments, participating in discussions and sharing your photos and videos. Join our community on Facebook, submit your photos on Instagram, follow us on Twitter and check us out on YouTube.



**GO MOBILE.** Take a multimedia tour of your vehicle on your mobile device. Visit the Chrysler Group LLC page in iTunes® from your smartphone or iPad® to download the most up-to-date vehicle apps. Log on to the [ramtrucks.com](http://ramtrucks.com) mobile site for an at-a-glance review of what you need to know about your Ram truck. Experience visual and interactive demonstrations while gaining access to product information at your fingertips, wherever you go.